

# Příloha č.1 k prohlášení vlastníka domu č.p.445 na jednotky

**ČÍSLO POPISNÉ: 445**

**ULICE: CHARKOVSKÁ**

**KAT.ÚZEMÍ: VRŠOVICE**

**OBEC: PRAHA 10**

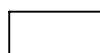

- BYTOVÉ JEDNOTKY



- SPOLEČNÉ PROSTORY



- BEZPODLAHOVÉ PLOCHY



- NEBYTOVÝ PROSTOR



- BALKONY, TERASY

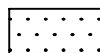

- SPOLEČNÉ PRO DANÉ JEDNOTKY

**1.P.P.  
Charkovská 1**

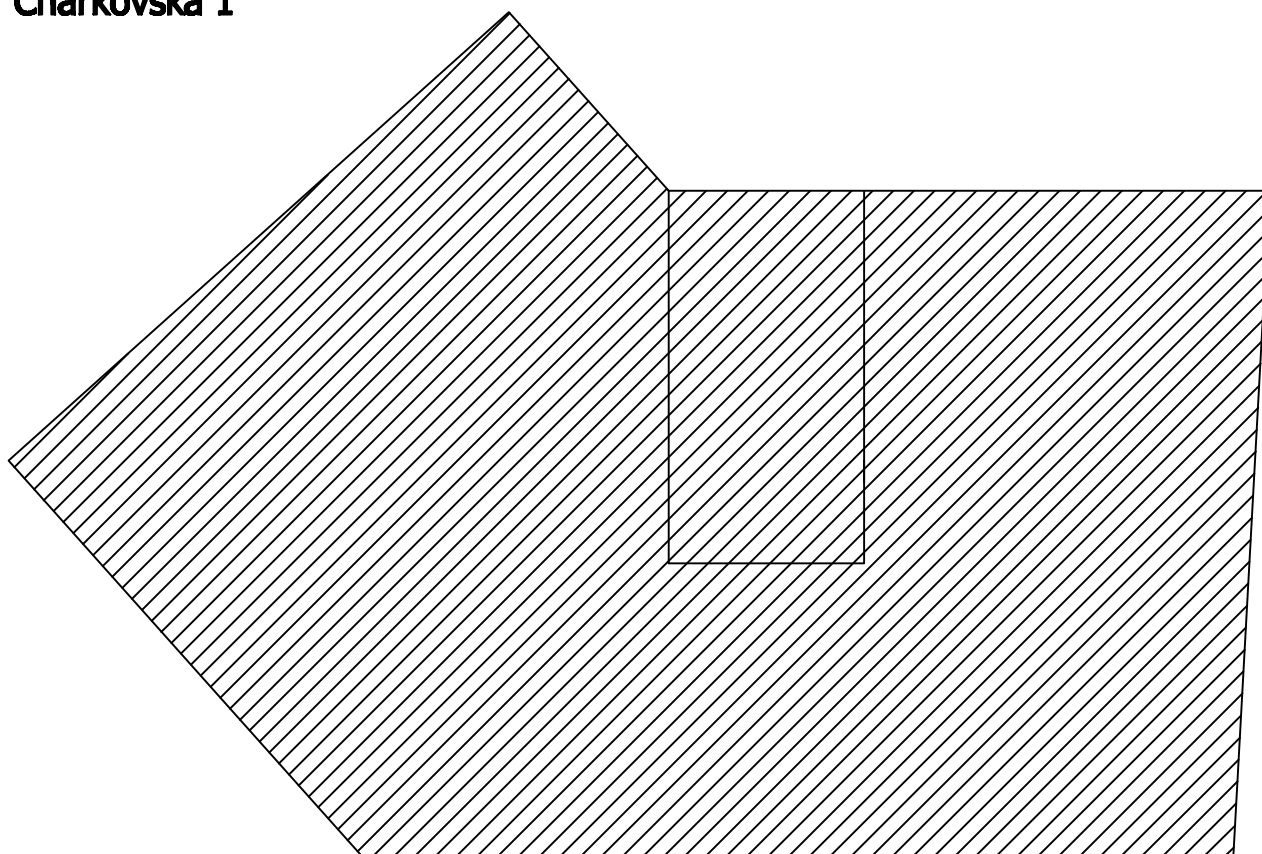

**1.N.P.  
Charkovská 1**

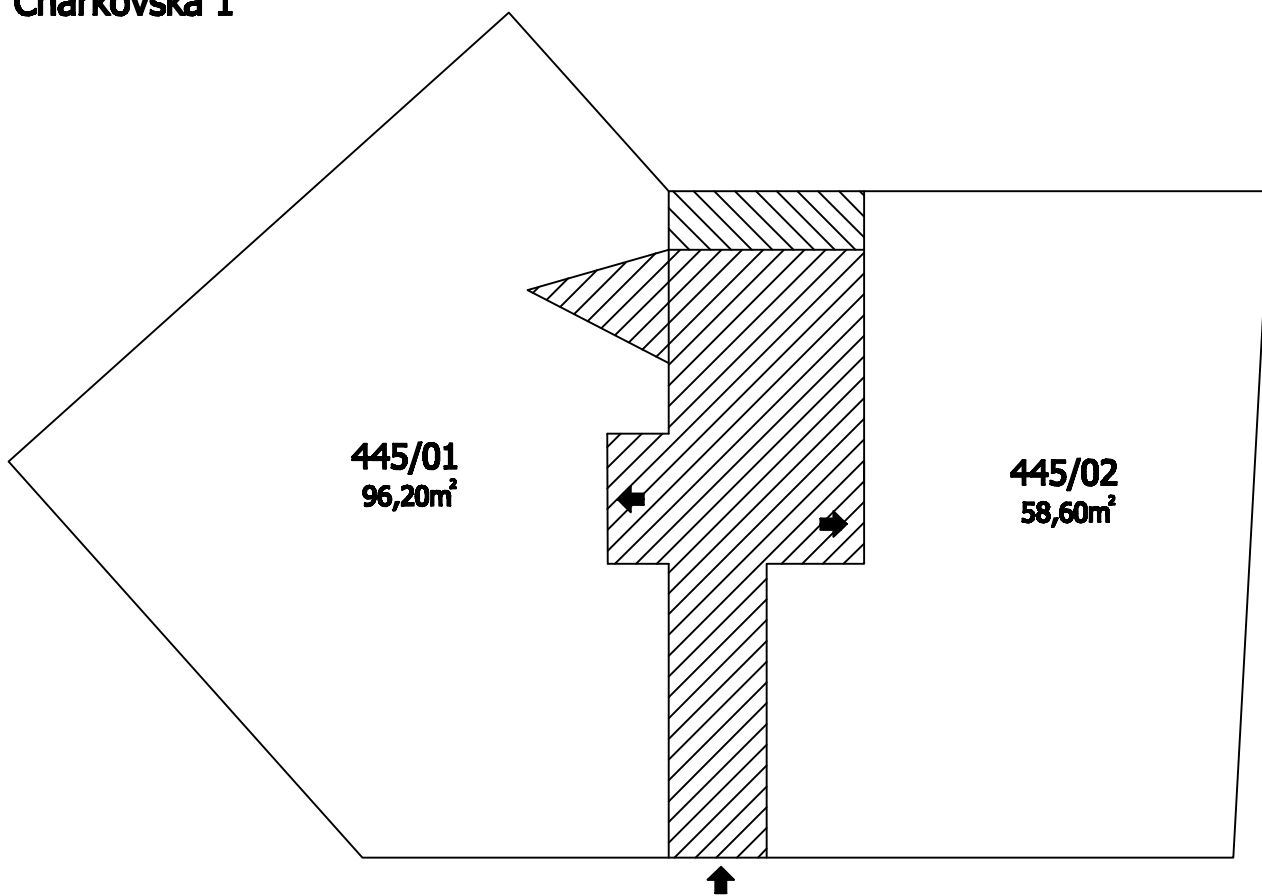

**2.N.P.  
Charkovská 1**

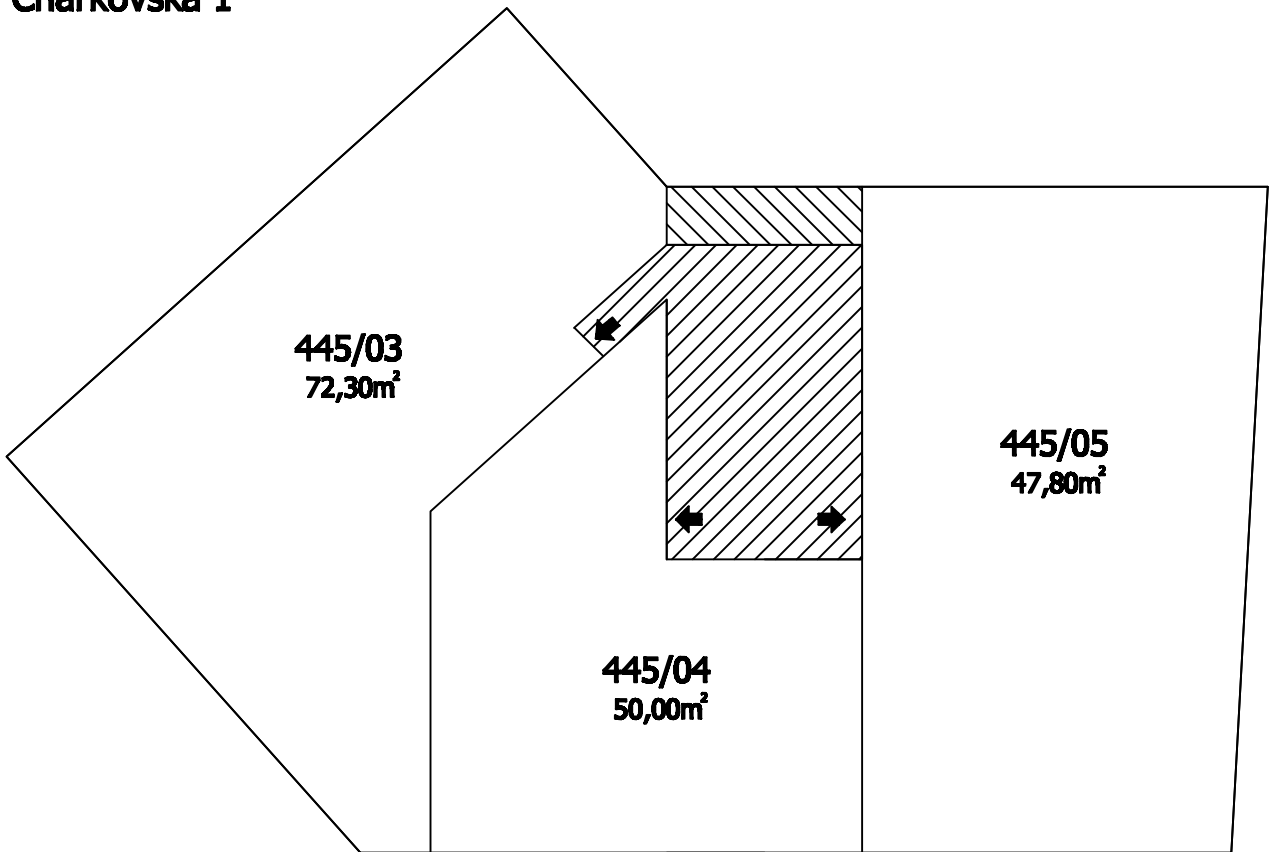

**3.N.P.  
Charkovská 1**

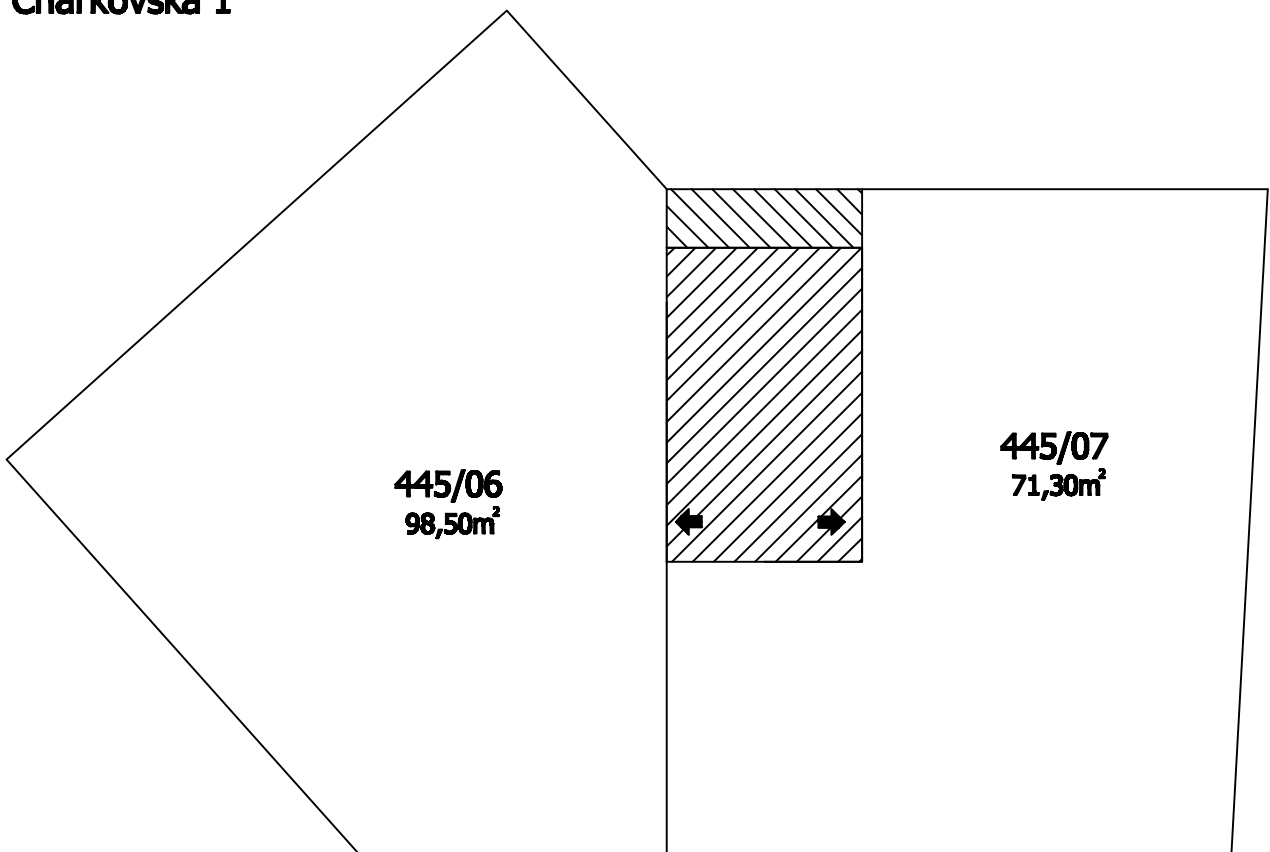

**4.N.P.  
Charkovská 1**

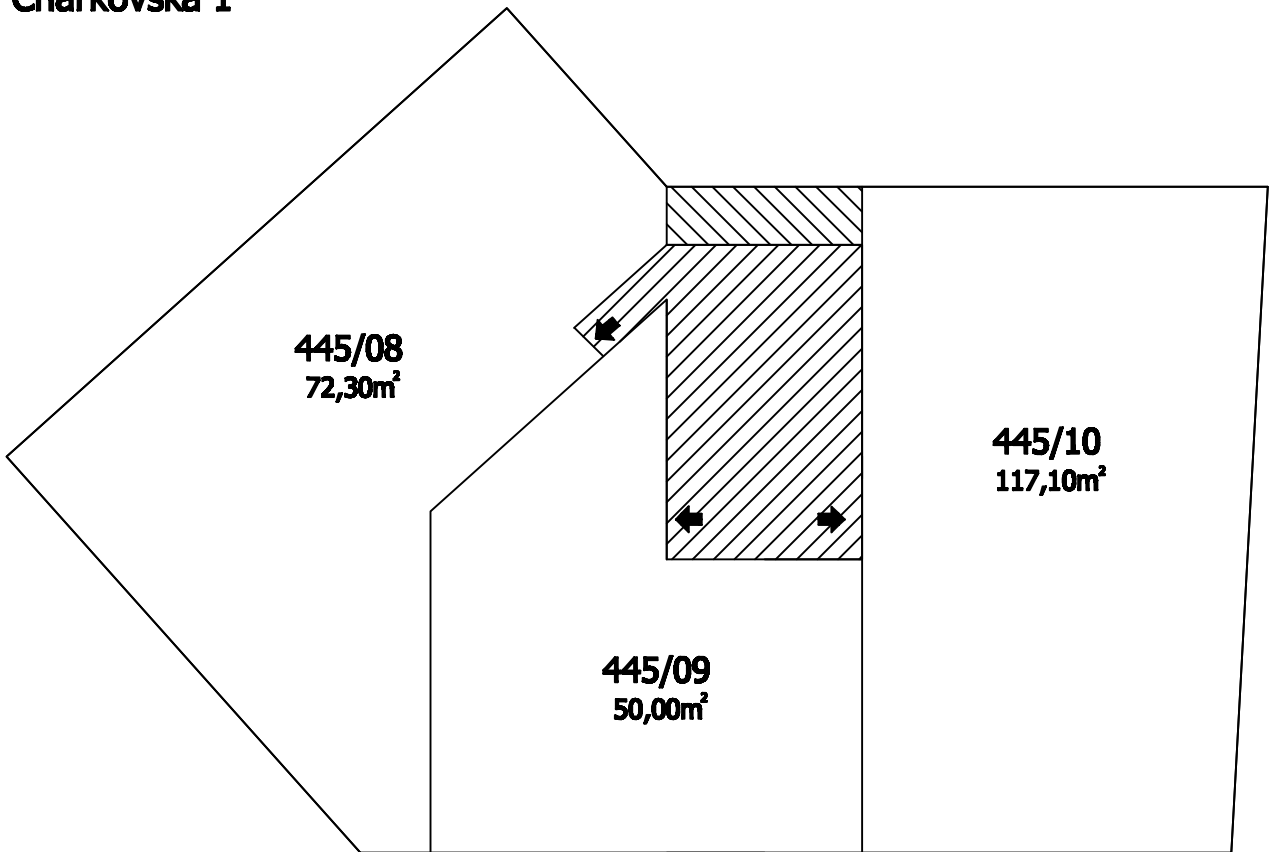

**5.N.P.  
Charkovská 1**

